

OMRON

Automatic Blood Pressure Monitor

Model HEM-7181

Instruction Manual



Table of Contents

- Introduction
Important Safety Information
1. Know Your Monitor
 2. Preparation
 3. Using Your Monitor
 4. Using Memory Function
 5. Other Settings
 6. Error Messages and Troubleshooting
 7. Maintenance
 8. Optional Accessories
 9. Specifications
 10. Guidance and Manufacturer's Declaration

Scan to Register Your Warranty online*



Model No:
Serial No:
Date of Purchase:
----- Sign & Stamp of Retailer

Register your warranty online with OMRON today!
With online warranty registration, you will now be able to:

- Do away with manual forms that need to be sent out
- No need to keep receipts and warranty cards after online registration
- Receive enhanced customer support from OMRON
- Get updated on important information regarding product updates or recommendations

REGISTER WARRANTY ONLINE

Please keep your original receipt as proof of purchase and register for warranty at

*For Further Terms and Conditions of Standard / Extended / Add-on warranty & Registration of Online warranty, please visit the warranty website.

<https://www.omronhealthcare-ap.com/in/warranty>

Promotional Warranty **As mentioned on the product (Refer Terms & conditions as below)

**TERMS & CONDITIONS

1Year Extended Warranty: To avail additional one year extended warranty on specific products as mentioned over the box subject to standard warranty terms and conditions user need to complete warranty registration within 60 days of purchase on our website www.omronhealthcare-ap.com/in/warranty. Post successful registration user shall receive an automated acknowledgement email which is to be presented at the time of available warranty services within extended warranty period. Extended warranty shall only be provided if user has successfully registered on our website and secure the acknowledgment email. To check if your product carries one-year extended warranty please visit our website as mentioned above.

For Any Additional information on warranty on your Product
Please contact us @

OMRON HEALTHCARE INDIA PVT. LTD.
6th Floor, B-Block, Sevia Tower, Plot No-19, Sector-18, Udyog Vihar, Maruti Industrial Complex, Gurugram, Haryana (India) – 122 008
Contact: 1800-419-0492 (Toll Free), Email: callcentre@omron.com
Operating hours: Monday – Friday 9 AM – 5:30 PM,
Closed: Saturday, Sunday & Public Holiday

Introduction

Thank you for purchasing the OMRON Automatic Blood Pressure Monitor. This blood pressure monitor uses the oscillometric method of blood pressure measurement. This means this monitor detects your blood movement through your brachial artery and converts the movements into a digital reading.

Safety Instructions

This instruction manual provides you with important information about the OMRON Automatic Blood Pressure Monitor. To ensure the safe and proper use of this monitor, READ and UNDERSTAND all of these instructions. **If you do not understand these instructions or have any questions, contact your local OMRON representative before attempting to use this monitor. For specific information about your own blood pressure, consult with your physician.**

Intended Use

Intended Purpose

This device is a digital monitor intended for use in measuring blood pressure and pulse rate in adult patient population. The device detects the appearance of irregular heartbeats during measurement and indicates this via a symbol with the measurement result.

Intended Patients

Adult patient population

Intended Users

Adult population (may include patients themselves) who can understand this instruction manual.

Clinical Benefit

Patient's blood pressure can be measured non-invasively and simply in the home environment.

Type of Use

This monitor is intended to be multiple patient multiple use.

Limitation

Patient's arm circumference must be 17 - 42 cm.

Indication

This device is used by healthy individuals, patients with hypertension, patients with health-conscious individuals, in a general household situation for measuring blood pressure and pulse rate.

Receiving and Inspection

Remove this monitor and other components from the packaging and inspect for damage. If this monitor or any other components is damaged, DO NOT USE and consult with your local OMRON representative.

Important Safety Information

Read the Important Safety Information in this instruction manual before using this monitor. Follow this instruction manual thoroughly for your safety. Keep for future reference. **For specific information about your own blood pressure, consult with your physician.**

Contraindications

- DO NOT use this monitor on an injured arm or an arm under medical treatment.
- DO NOT apply the arm cuff on your arm while on an intravenous drip or blood transfusion.
- DO NOT use this monitor on infants, toddlers, children or persons who cannot express themselves.

Side Effects

- Taking measurements more often than necessary may cause bruising due to blood flow interference.
- Inflating to a higher pressure than necessary may result in bruising of the arm where the cuff is applied. NOTE: refer to "If your systolic pressure is more than 210 mmHg" in section 3 of this instruction manual for additional information.
- Stop using this monitor and consult with your physician if you experience skin irritation or discomfort.

Warning Indicates a potentially hazardous situation which, if not avoided, could result in death or serious injury.

- DO NOT adjust medication (including altering your use of any drug or treatment) based on readings from this blood pressure monitor. Take medication as prescribed by your physician. ONLY a physician is qualified to diagnose and treat high blood pressure and heart related conditions.
- NEVER diagnose or treat yourself based on your readings. ALWAYS consult with your physician.
- If you are experiencing any symptoms or concerns, consult with your physician.
- DO NOT postpone/stop regular checkups or physician visits based on the results that you are getting from this monitor.
- DO NOT use this monitor in areas containing high frequency (HF) surgical equipment, magnetic resonance imaging (MRI) equipment, computerized tomography (CT) scanners. This may result in incorrect operation of the monitor and/or cause an inaccurate reading.
- DO NOT use this monitor in oxygen rich environments or near flammable gas.
- Consult with your physician before using this monitor if you have common arrhythmias such as atrial or ventricular premature beats or atrial fibrillation; arterial sclerosis; poor perfusion; diabetes; pregnancy; pre-eclampsia or renal disease. NOTE that any of these conditions in addition to patient motion, trembling, or shivering may affect the measurement reading.
- To help avoid strangulation, keep the air tube and AC adapter cable away from infants, toddlers and children.
- This product contains small parts that may cause a choking hazard if swallowed by infants, toddlers and children.

AC Adapter (optional accessory) Handling and Usage

- DO NOT use the AC adapter if this monitor or the AC adapter cable is damaged. If this monitor or the cable is damaged, turn off the power and unplug the AC adapter immediately.
- Plug the AC adapter into the appropriate voltage outlet. DO NOT use in a multi-outlet plug.
- NEVER plug in or unplug the AC adapter from the electric outlet with wet hands.
- DO NOT disassemble or attempt to repair the AC adapter.

Battery Handling and Usage

- Keep the batteries out of the reach of infants, toddlers and children.

Precaution Indicates a potentially hazardous situation which, if not avoided, may result in minor or moderate injury to the user or patient, or cause damage to the equipment or other property.

- Consult with your physician before using this monitor on an arm where intravascular access or therapy, or an arterio-venous (A-V) shunt, is present because of temporary interference to blood flow and could result in injury.
- Consult with your physician before using this monitor if you have had a mastectomy or lymph node clearance.
- Consult with your physician before using this monitor if you have severe blood flow problems or blood disorders as cuff inflation can cause bruising.
- ONLY inflate the arm cuff when it is applied on your upper arm.

1. Know Your Monitor

1.1 Contents

Monitor, arm cuff (HEM-CR24), 4 "AA" batteries, instruction manual

1.2 Monitor and Arm Cuff

Front of the monitor

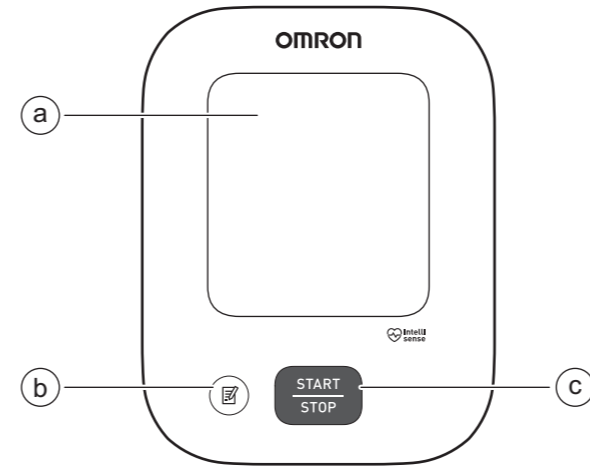

- (a) Display
- (b) [Memory] button
- (c) [START/STOP] button

Left side and bottom of the monitor

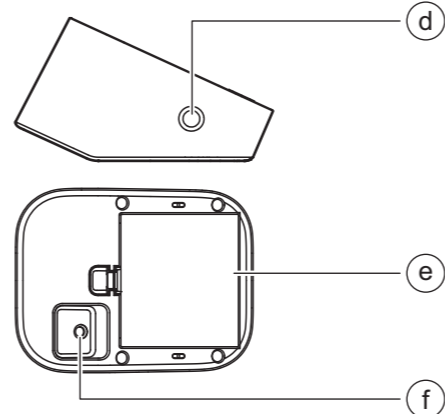

- (d) Air jack
- (e) Battery compartment
- (f) AC adapter jack

Arm cuff

(Upper arm circumference: 22 - 32 cm)

- (g) Air plug
- (h) Air tube

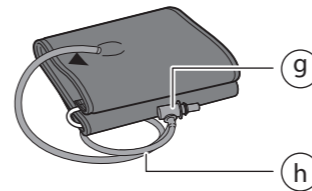

1.3 Display and Symbols

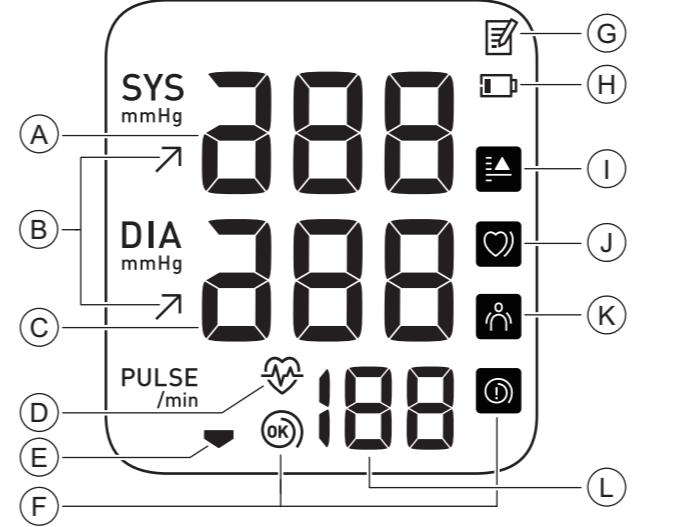

(A)	Systolic blood pressure reading
(B)	Trend indicator Appears when your systolic and/or diastolic blood pressure readings are higher than the previous readings.
(C)	Diastolic blood pressure reading
(D)	Heartbeat symbol Flashes while taking a measurement.
(E)	Deflation symbol Appears during cuff deflation.
(F)	Cuff wrap guide symbol (OK) Appears if the arm cuff is wrapped around the arm correctly while taking a measurement. It also appears when viewing past readings.
(F)	Cuff wrap guide symbol (loose) Appears if the arm cuff is not wrapped around the arm correctly while taking a measurement. It also appears when viewing past readings.
(G)	Memory symbol Appears when viewing readings stored in the memory.

(H)	Low battery symbol Flashes when batteries are low.
(I)	Depleted battery symbol Appears when batteries are depleted.
(J)	Hypertension symbol Appears if your systolic blood pressure is 135 mmHg or above and/or your diastolic blood pressure is 85 mmHg or above. Irregular heartbeat symbol • Appears when irregular rhythm is detected 2 or more times during a measurement. • This symbol may be displayed when the monitor detects arm movements while taking a measurement. Refer to section 6 for more information. An irregular heartbeat rhythm is defined as a rhythm that is 25 % less or 25 % more than the average rhythm detected while your monitor is measuring blood pressure. Irregular Heartbeat Normal Heartbeat
(K)	Movement error symbol Alerts you of any body movement that will affect the blood pressure readings. If it appears, remove the arm cuff and wait for 2 to 3 minutes. Then, reapply the cuff, remain still, and take another measurement.
(L)	Pulse display • Pulse rate appears after the measurement.

2023 ESH* Guidelines for the management of arterial hypertension

Definitions of hypertension by office and home blood pressure levels

	Office	Home
Systolic Blood Pressure	≥ 140 mmHg	≥ 135 mmHg
Diastolic Blood Pressure	≥ 90 mmHg	≥ 85 mmHg

These ranges are from statistical values for blood pressure.

* European Society of Hypertension practice guidelines for office and out-of-office blood pressure measurement.

Warning

- NEVER diagnose or treat yourself based on your readings. ALWAYS consult with your physician.

2. Preparation

2.1 Installing Batteries

1. Remove the battery cover.

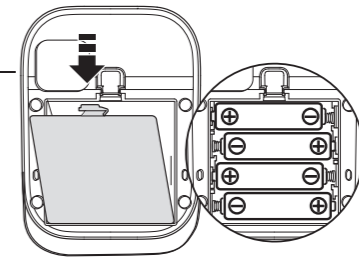

2. Insert 4 "AA" batteries as indicated in the battery compartment.

3. Close the battery cover.

Note

- When the "Low battery" symbol flashes on the display, it is recommended that you replace the batteries.
- To replace the batteries, turn your monitor off and remove all batteries. Then replace with 4 new batteries at the same time.
- Replacing the batteries will not delete previous readings.
- The supplied batteries may have a shorter life span than new batteries.
- Disposal of used batteries should be carried out in accordance with local regulations.

2.2 Blood Pressure Measurement Tips

To help ensure an accurate reading, follow these directions:

- Stress raises blood pressure. Avoid taking measurements during stressful times.
- Measurements should be taken in a quiet place.
- It is important to take measurements at the same time each day. Taking measurements in the morning and in the evening is recommended.
- Remember to have a record of your blood pressure and pulse readings for your physician. A single measurement does not provide an accurate indication of your true blood pressure. You need to take and record several readings over a period of time.

Precaution

- Avoid bathing, drinking alcohol or caffeine, smoking, exercising and eating for at least 30 minutes before taking a measurement.
- Rest for at least 5 minutes before taking a measurement.

2.3 Applying the Arm Cuff

Note

- The following steps are for applying the arm cuff to your left arm. When you take a measurement on your right arm, follow the cuff wrap instructions for use on your right arm mentioned under "To take a measurement on your right arm" located at the end of this sub-section.
- Blood pressure can differ between the right arm and the left arm, and the measured blood pressure readings can be different. It is recommended that you always use the same arm for measurement. If the readings between both arms differ substantially, check with your physician to determine as to which arm to use for your measurements.

Precaution

- Remove tight-fitting or thick clothing from your arm while taking a measurement.

1. Plug the arm cuff into your monitor by inserting the air plug into the air jack.



2. Place your hand through the cuff loop. Pull the cuff until it reaches your upper left arm.



Note

- The bottom edge of the arm cuff should be 1 to 2 cm above the inside of your elbow. The air tube should be on the inside of your arm and aligned with your middle finger.

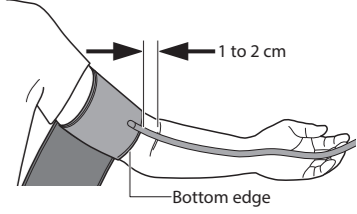

3. Make sure that the air tube is positioned on the inside of your arm and wrap the cuff securely, so it cannot move around your arm.



To take a measurement on your right arm

When you take a measurement on your right arm, the air tube should run along the side of your elbow, along the bottom of your arm. Be careful not to rest your arm on the air tube.



2.4 Sitting Correctly

To take a measurement, you need to be relaxed and comfortably seated in a room with a comfortable temperature. Place your arm on the table.

- Sit in a comfortable chair with your back and arm supported.
- Keep your feet flat and your legs uncrossed.
- The arm cuff should be placed on your arm at the same level as your heart, with the arm resting comfortably on a table.

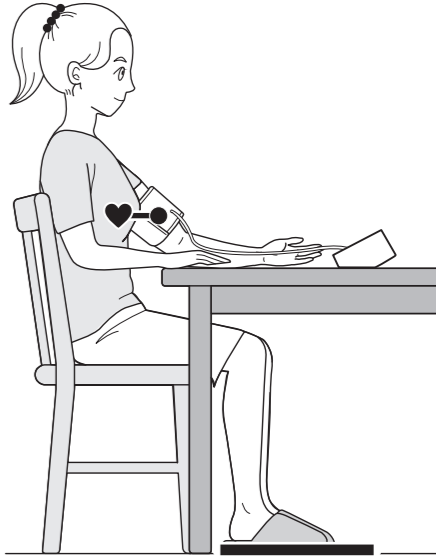

3. Using Your Monitor

This monitor tracks readings for 1 user. If you are sharing it with another user, manually track your readings separately.

3.1 Taking a Measurement

Note
 • To stop the measurement, press the [START/STOP] button once to deflate the arm cuff.

⚠️ Precaution

- DO NOT use this monitor with other medical electrical (ME) equipment simultaneously. This may result in incorrect operation of the devices and/or cause an inaccurate reading.
- Remain still and DO NOT talk while taking a measurement.

- Press the [START/STOP] button. All symbols appear on the display before starting the measurement.
- Remain still and do not talk until the entire measurement process is complete.

The “” symbol flashes at every heartbeat.

Note

- The “” symbol appears if the arm cuff is wrapped around the arm correctly.
- When the “” symbol is displayed, the arm cuff is not applied correctly. Press the [START/STOP] button to turn your monitor off, then apply the cuff correctly.
- Trend indicator “” appears when your systolic and/or diastolic blood pressure readings are higher than the previous readings.

After your monitor has detected your blood pressure and pulse rate, the cuff automatically deflates. Your blood pressure and pulse rate are displayed.

If either the systolic or the diastolic reading is high (refer to sub-section 1.3), the “” symbol appears.

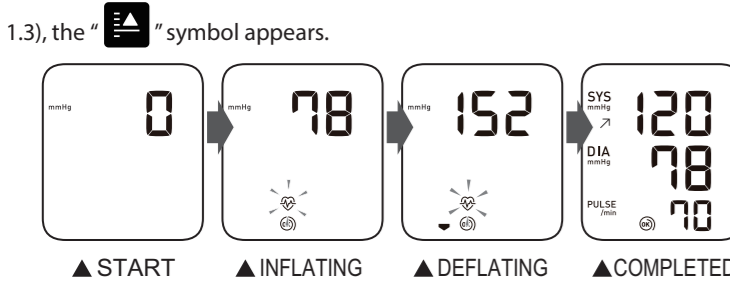

- Press the [START/STOP] button to turn your monitor off.

Note

- Your monitor automatically turns off after 2 minutes.
- Wait 2 - 3 minutes between measurements. The wait time allows the arteries to return to their pre-measurement state. You may need to increase the wait time depending on your individual physiological characteristics.

■ If your systolic pressure is more than 210 mmHg

If your systolic pressure is more than 210 mmHg, take a measurement manually. After the arm cuff starts to inflate, press and hold the [START/STOP] button until the monitor inflates 30 to 40 mmHg higher than your expected systolic pressure.

- Note**
 • Do not inflate above 299 mmHg.

⚠️ Precaution

- Inflating to a higher pressure than necessary may result in bruising of the arm where the cuff is applied.

4. Using Memory Function

Your monitor automatically stores up to 14 readings.

4.1 Viewing the Readings Stored in Memory

- Press the button once.

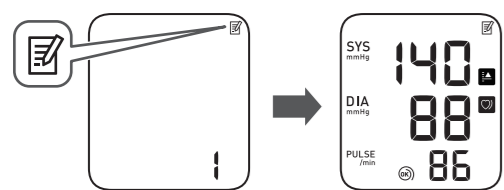

The memory number appears for 1.5 seconds before the pulse rate is displayed. The most recent reading stored in the memory will be numbered as “1”.

Pressing and holding the button will scroll through the previous readings rapidly.

Note

- If the reading was high (refer to sub-section 1.3), the “” symbol appears.
- If there are no readings stored in the memory, the screen to the right is displayed.
- If the memory is full, new readings will replace the old readings, starting with the oldest reading.

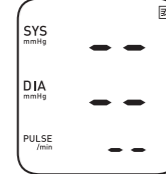

- Press the button repeatedly to scroll through the previous readings stored in the memory.

5. Other Settings

5.1 Restoring Your Monitor to the Default Settings

To delete all the information stored in your monitor, follow the instructions below. Make sure that your monitor is turned off.

- While holding the

button down, press and hold the [START/STOP] button for more than 3 seconds. The display to the right flashes.

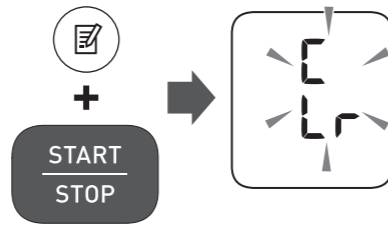

- While holding the

button down again, press and hold the [START/STOP] button for more than 3 seconds. The display stops flashing, then your monitor is restored to the default settings.

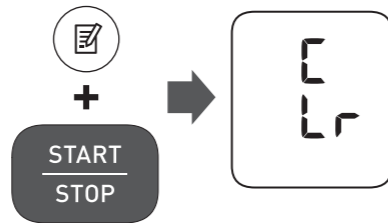

- Press the [START/STOP] button to turn your monitor off.

6. Error Messages and Troubleshooting

If any of the below problems occur during measurement, check to make sure that no other electrical device is within 30 cm of the monitor. If the problem persists, refer to the table below.

Display/Problem	Possible Cause	Solution
appears or the arm cuff does not inflate.	The [START/STOP] button was pressed while the arm cuff is not applied.	Press the [START/STOP] button again to turn the monitor off.
	Air plug is not completely plugged into the monitor.	Insert the air plug securely. Refer to sub-section 2.3.
	The arm cuff is not applied correctly.	Apply the arm cuff correctly, then take another measurement. Refer to sub-section 2.3.
appears or a measurement cannot be completed after the arm cuff inflates.	Air is leaking from the arm cuff.	Replace the arm cuff with a new one. Refer to section 8.
	Moving or talking during a measurement causes the arm cuff to not inflate sufficiently.	Remain still and do not talk during a measurement. If “E2” appears repeatedly, inflate the arm cuff manually until the systolic pressure is 30 to 40 mmHg above your previous readings. Refer to sub-section 3.1.
appears	The systolic pressure is above 210 mmHg and a measurement cannot be taken.	Refer to sub-section 3.1.
appears	The arm cuff is inflated exceeding the maximum allowable pressure.	Do not touch the arm cuff and/or bend the air tube while taking a measurement. If inflating the arm cuff manually, refer to sub-section 3.1.
appears	Moving or talking during a measurement results in vibrations that disrupt the measurement.	Remain still and do not talk during a measurement.
appears	Apply the arm cuff correctly, then take another measurement. Refer to sub-section 2.3. Remain still and sit correctly during a measurement. Remain still and sit correctly during a measurement. If “” continues to appear, it is recommended that you consult with your physician.	
does not flash during a measurement	The pulse rate is not detected correctly.	
appears	The monitor has malfunctioned.	Press the [START/STOP] button again. If “Er” still appears, contact your OMRON retail outlet or distributor.
flashes	Batteries are low.	Replacing all 4 batteries with new ones is recommended. Refer to sub-section 2.1.

Display/Problem	Possible Cause	Solution
appears, or the monitor is turned off unexpectedly during a measurement.	Batteries are depleted.	Immediately replace all 4 batteries with new ones. Refer to sub-section 2.1.
Nothing appears on the display of the monitor.	Battery polarities are not properly aligned.	Check the battery installation for proper placement. Refer to sub-section 2.1.
Readings appear too high or too low.	Blood pressure varies constantly. Many factors including stress, time of day, and/or how you apply the arm cuff, may affect your blood pressure. Review sub-sections 2.2 - 2.4 and section 3.	
Any other problems occur.	Press the [START/STOP] button to turn the monitor off, then press it again to take a measurement. If the problem continues, remove all batteries and wait for 30 seconds. Then re-install batteries. If the problem still persists, contact your OMRON retail outlet or distributor.	

7. Maintenance

7.1 Maintenance

To protect your monitor from damage, follow the directions below:

- Changes or modifications not approved by the manufacturer will void the user warranty.

⚠️ Precaution

- DO NOT disassemble or attempt to repair this monitor or other components. This may cause an inaccurate reading.

7.2 Storage

Store your monitor and other components in a clean, safe location.

- Gently fold the air tube into the arm cuff.

Note

- Do not bend or crease the air tube excessively.

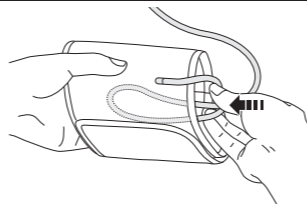

Do not store your monitor and other components:

- If your monitor and other components are wet.
- In locations exposed to extreme temperatures, humidity, direct sunlight, dust or corrosive vapors such as bleach.
- In locations exposed to vibrations or shocks.

7.3 Wiping the Monitor

- Do not use any abrasive or volatile cleaners.
- Use a soft dry cloth or a soft cloth moistened with mild (neutral) detergent to wipe your monitor and arm cuff and then wipe them with a dry cloth.
- Do not wash or immerse your monitor and arm cuff or other components in water.
- Do not use gasoline, thinners or similar solvents to wipe your monitor and arm cuff or other components.

7.4 Calibration and Service

- The accuracy of this blood pressure monitor has been carefully tested and is designed for a long service life.
- It is generally recommended to have the unit inspected every two years to ensure correct functioning and accuracy. Please consult your authorised OMRON dealer or the OMRON Customer Service at the address given on the packaging or attached literature.

8. Optional Accessories



- Note**
 • Do not throw the air plug away. The air plug can be applicable to the optional cuff.

AC Adapter

Model: HHP-BH01



Using the AC Adapter (optional accessory)

- Note**
 • Make sure not to place your monitor in a location where it is difficult to plug and unplug the AC adapter.

- Insert the AC adapter plug into the AC adapter jack on the bottom of your monitor.
- Plug the AC adapter into an electrical outlet. To unplug the AC adapter, unplug the AC adapter from the electrical outlet and then remove the AC adapter plug from the monitor.

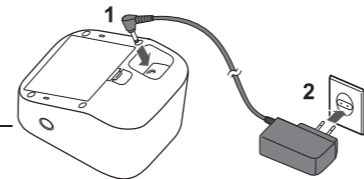

⚠️ Precaution

- ONLY use the AC adapter, arm cuff, batteries and accessories specified for this monitor. Use of unsupported AC adapters, arm cuffs and batteries may damage and/or may be hazardous to this monitor.

9. Specifications

Product description	Automatic Blood Pressure Monitor
Model	HEM-7181
Display	LCD digital display
Cuff pressure range	0 to 299 mmHg
Blood pressure measurement range	SYS: 60 to 260 mmHg DIA: 40 to 215 mmHg
Pulse measurement range	40 to 180 beats / min.
Accuracy	Pressure: ± 3 mmHg Pulse: ± 5 % of display reading
Measurement method	Oscillometric method
Operation mode	Continuous operation
IP classification	Monitor: IP21 Optional AC adapter: IP22
Rating	DC6 V 4 W
Power source	4 “AA” batteries 1.5 V or Optional AC adapter (INPUT AC100 - 240 V 50 - 60 Hz 0.12 - 0.065 A)
Battery life	Approx. 1500 measurements (Using new alkaline batteries and included arm cuff. Depending on the type of battery and arm cuff.) Monitor: 5 years or the time when reaching 30000 times of use. Arm cuff: 5 years or the time when reaching 10000 times of use. Optional AC adapter: 5 years
Durable period (Service life)	
Operating conditions	+10 °C to +40 °C / 15 to 90 % RH (non-condensing) / 800 to 1060 hPa
Storage / Transport conditions	-20 °C to +60 °C / 10 to 90 % RH (non-condensing)
Weight	Monitor: approx. 260 g not including batteries Arm cuff: approx. 110 g
Dimensions	Monitor: approx. 98 mm (W) × 79 mm (H) × 138 mm (L) Arm cuff: approx. 146 mm × 466 mm (air tube: 610 mm)
Cuff circumference applicable to the monitor	17 to 42 cm (included arm cuff: 22 to 32 cm)
Memory	Stores up to 14 readings
Contents	Monitor, arm cuff (HEM-CR24), 4 “AA” batteries, instruction manual
Protection against electric shock	Internally powered ME equipment (when using only batteries) Class II ME equipment (when using optional AC adapter)
Applied part	Type BF (arm cuff)

Note

- These specifications are subject to change without notice.
- This monitor is clinically investigated according to the requirements of EN ISO 81060-2:2014 and complies with EN ISO 81060-2:2019+A1:2020 +A2:2024. In the clinical validation study, K5 was used on 85 subjects for determination of diastolic blood pressure.
- This monitor has not been validated for use on pregnant patients.
- IP classification is degrees of protection provided by enclosures in accordance with IEC 60529. This monitor and optional AC adapter are protected against solid foreign objects of 12.5 mm diameter and greater such as a finger. This monitor is protected against vertically falling water drops which may cause issues during a normal operation. The optional AC adapter HHP-BH01 is protected against oblique falling water drops which may cause issues during a normal operation.
- Operation mode classification complies with IEC 60601-1.

10. Guidance and Manufacturer’s Declaration

CE 0197

- This OMRON product is produced under the strict quality system of OMRON HEALTHCARE Co., Ltd., Japan. The Core component for OMRON blood pressure monitors, which is the Pressure Sensor, is produced in Japan.
- Please report to the manufacturer and the regulatory authority in which you are established about any serious incident that has occurred in relation to this device.

Symbol	Symbols description
	Applied part - Type BF Degree of protection against electric shock (leakage current)
	CE Marking
	Class II equipment. Protection against electric shock
	Ingress protection degree provided by IEC 60529
	Serial number
	LOT number
	Medical Device
	Temperature limitation
	Humidity limitation
	Atmospheric pressure limitation
	Indication of connector polarity
	Identifier of cuffs compatible for the device
	OMRON's trademarked technology for blood pressure measurement
	Arm circumference
	Cuff positioning indicator for the left arm
	Artery mark
	Range pointer and brachial artery alignment position
	Range indicator of arm circumferences to help selection of the correct cuff size
	Need for the user to consult this instruction manual.
	Need for the user to follow this instruction manual thoroughly for your safety (Background: blue).
	Direct current
	Alternating current
	Date of manufacture
	BIS mark
	Efficiency level of power supply
	Not made with natural rubber latex
	LATEX FREE
	Unique device identifier
	Recycling mark
	Catalogue number

Important information regarding Electromagnetic Compatibility (EMC)

This device conforms to the EN 60601-1-2:2015+A1:2021 Electromagnetic Compatibility (EMC) standard. Further documentation in accordance with this EMC standard is available at <https://healthcare.omron.com/electro-magnetic-compatibility> Refer to the EMC information for this device on the website.

Correct Disposal of This Product (Waste Electrical & Electronic Equipment)

This marking shown on the product or its literature, indicates that it should not be disposed of, with other household wastes at the end of its working life.

To prevent possible harm to the environment or human health from uncontrolled waste disposal, please separate this product from other types of wastes and recycle it responsibly to promote the sustainable reuse of material resources.

Household users should contact either the retailer where they purchased this product, or their local government office, for details of where and how they can return this item for environmentally safe recycling. Business users should contact their supplier and check the terms and conditions of the purchase contract. This product should not be mixed with other commercial waste for disposal.